

SOFT MONITOUCH

# TELLUS and V-Server

**⚠ Safety Considerations**

- For safe operation, read the instruction manual or user manual that comes with the product carefully or consult the distributor from which you purchased the product, before using the product.
- Products introduced in this catalog have not been designed or manufactured for such applications in a system or equipment that will affect human bodies or lives.
- Customers, who want to use the products introduced in this catalog for special systems or devices such as for atomic-energy control, aerospace use, medical use, passenger vehicle, and traffic control, are requested to consult the Hakko Overseas Sales Section.
- Customers are requested to prepare safety measures when they apply the products introduced in this catalog to such systems or facilities that will affect human lives or cause severe damage to property if the products become faulty.
- For safe operation, wiring should be conducted only by qualified engineers who have sufficient technical knowledge about electrical work or wiring.

**Notes to consider before purchasing**

- Appearance and specifications are subject to modification without prior notice due to technical improvements.
- Colors in the catalog may differ from the actual colors due to printing inaccuracies.
- Consult your distributor or us for further information about products in this catalog.

**www.monitouch.com**

**Hakko Electronics Co., Ltd.**

Overseas Sales Department  
890-1 Kamikashiwano-machi,  
Hakusan, Ishikawa 924-0035, Japan

- Tel  
+81-76-274-2144
- Fax  
+81-76-274-5136
- E-mail  
sales@hakko-elec.co.jp

Distributor

\* Product specifications and design are subject to modification.  
\* Combined images are used for the screen images.  
\* Product colors may differ from colors in brochure photos due to printing.  
\* Windows and Excel are trademarks of Microsoft (USA) in the U.S. and other countries.  
\* Other company and product names in this brochure are registered trademarks.  
\* Printed with environment-friendly soy ink.

**Bringing the factory floor to your desk**





TELLUS and V-Server links Monitouch in a factory with a PC in the office, so that your PC can collect on-site data or monitor and control the equipment in the factory. This combination enables efficient and low-cost production; immediate and appropriate responses to the condition of the line is possible from anywhere.

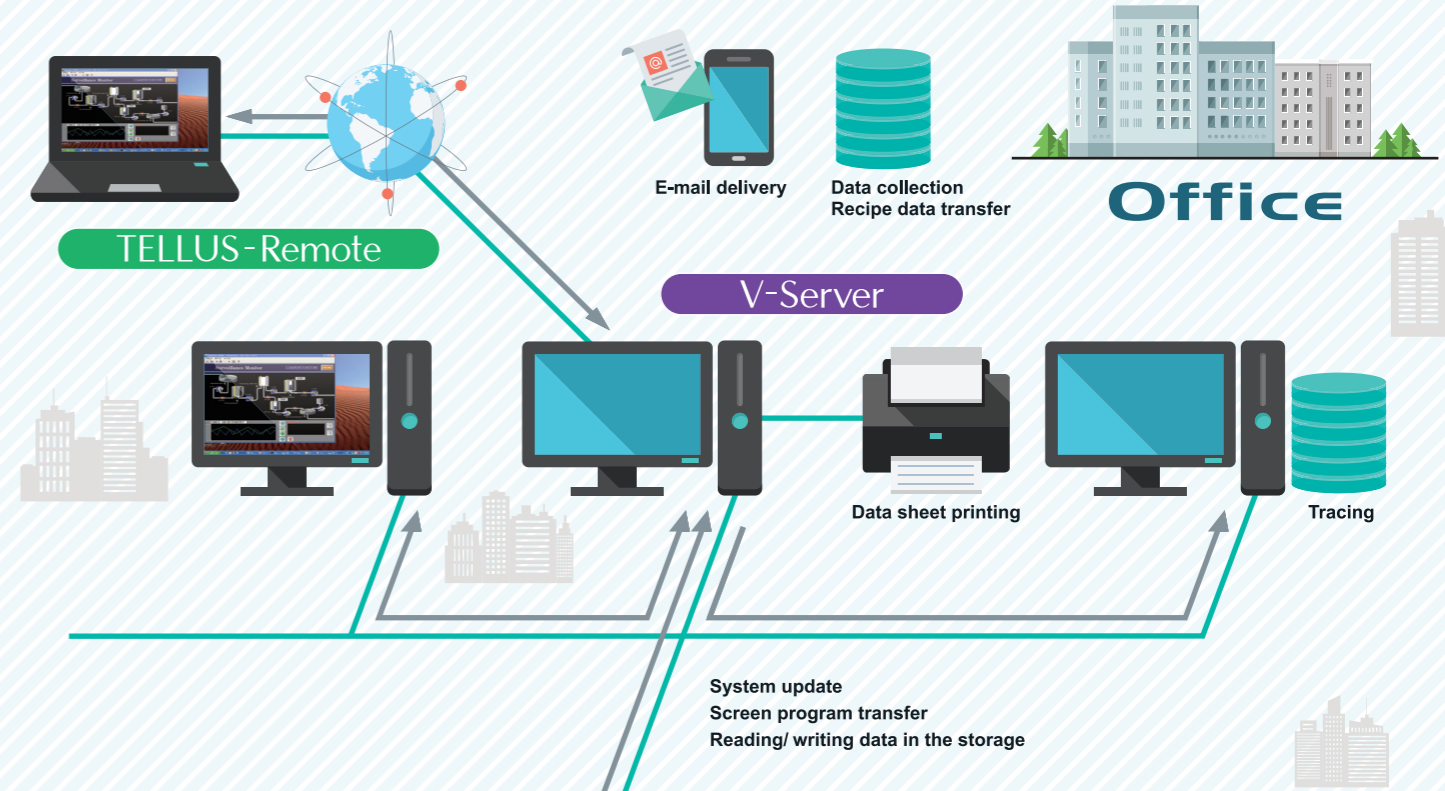

## V-Server P.4

### Collection and saving of current data

Linkage of a PC and Monitouch via Ethernet enables collection and saving of on-site data in real time.



## TELLUS-Remote P.6

### Remote monitoring and control

Installation of the TELLUS and V-Server software package allows your PC to monitor and control the production site via Monitouch through Ethernet.

## TELLUS-HMI P.7

### Monitouch functions available on your PC

Equivalent functions of Monitouch are available on your PC by directly connecting to PLC after installing TELLUS software on your PC. It is possible to display an image of the entire line on a large screen display and link various Windows applications.

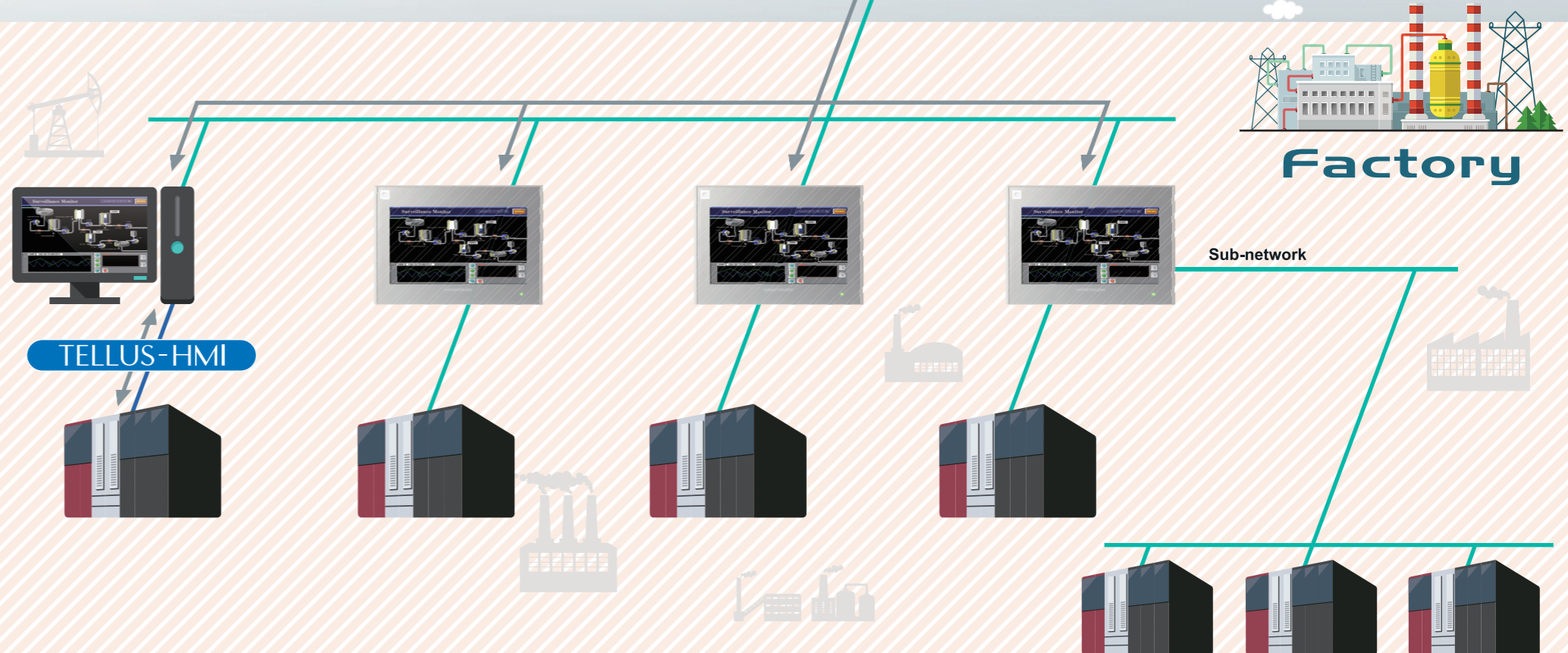

# Linking your office and factory for collection of production data

## V-Server

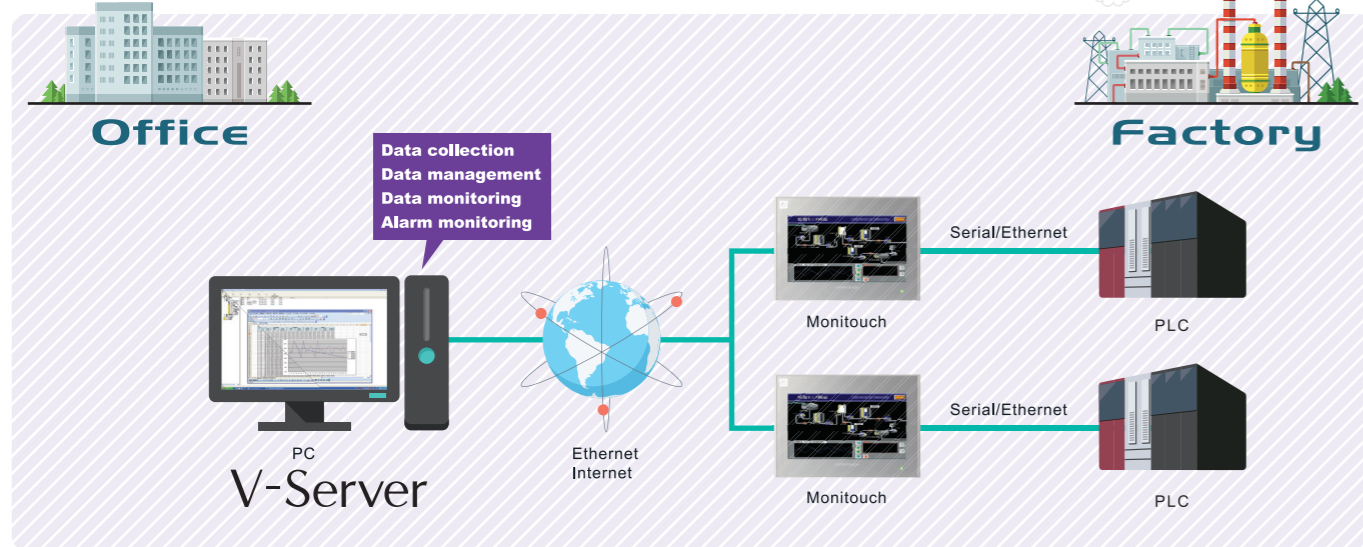

### Easy to make daily and monthly reports (DDE function)

The tag data registered in V-Server can be pasted to Excel files in DDE format. This makes it easy to generate daily/monthly reports.

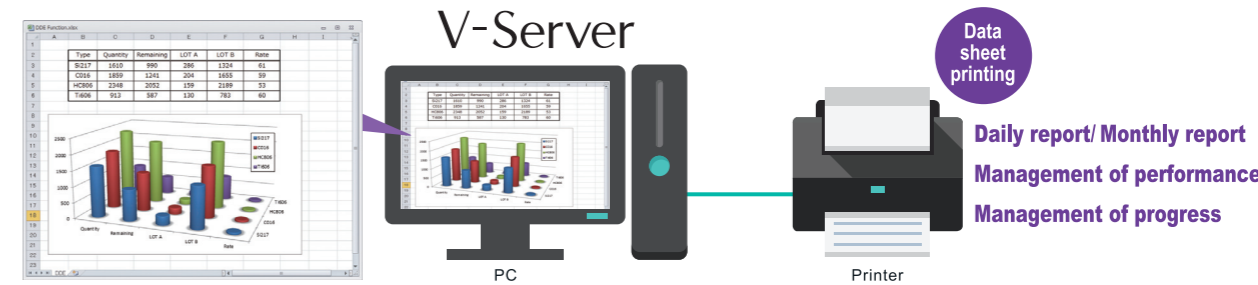

### Data saving without programming

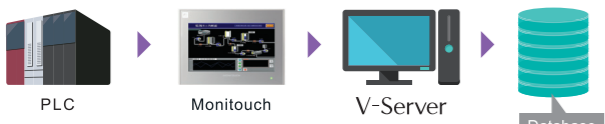

**Data logging function**  
Production data can be regularly read out and saved in database, CSV/ Excel format.

**Readout of sampling data**  
Sampling data stored in Monitouch can be read out and saved in database or CSV/ Excel format.

### Consolidated recipe data management

Consolidation of recipe data by the upper-level PC reduces the process of recipe registration and modification for each piece of equipment and provides consistent product quality.

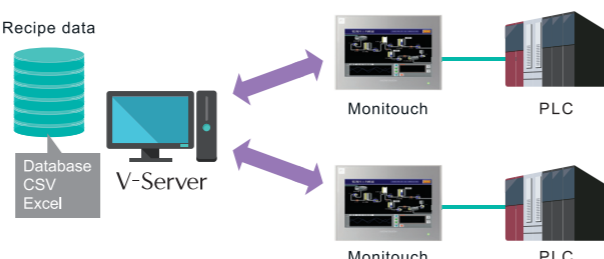

### Quick response to on-site problems

Alarm data can be monitored to display historical data or a list of alarms currently occurring. In addition, an e-mail alert can be sent immediately when a critical alarm occurs.

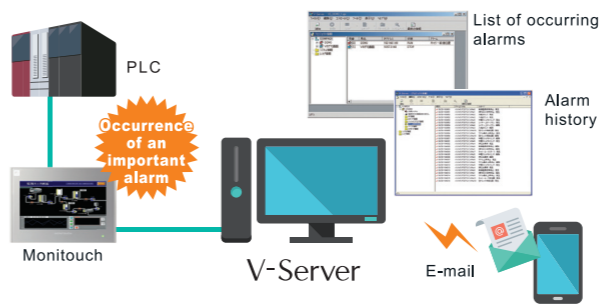

### Updating of Monitouch data from the office

You can update the system program of multiple Monitouch panels at a time or transfer the screen program to them all together.

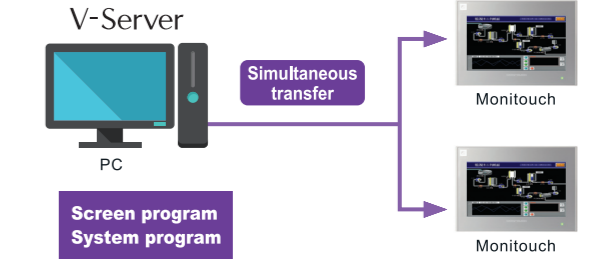

### Consolidated management of data of PLCs of various types and manufacturers

V-Server collects information from peripheral devices through Monitouch as a gateway. It is possible to collect information from the devices of any type and manufacturer if they can be connected to Monitouch.

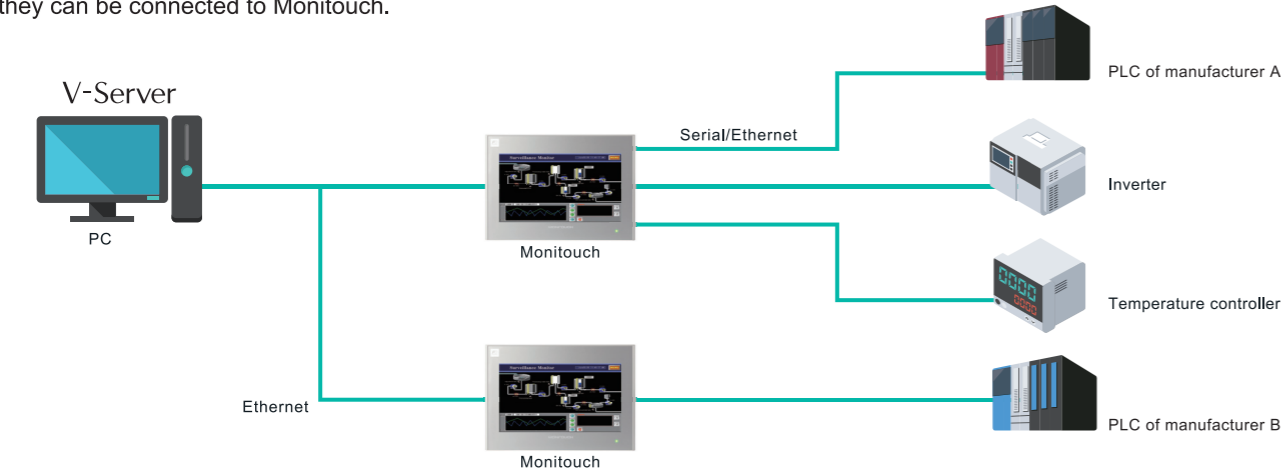

### Reading and writing of stored data

Files on a SD card inserted in Monitouch can be read out to a PC, and files edited on a PC can be written onto a SD card via Ethernet.

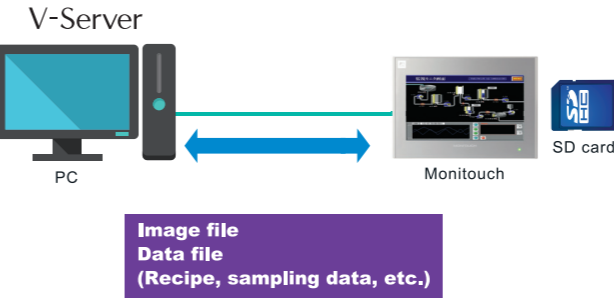

### Automatic actions in response to events

Various kinds of events can be set depending on the requirements of the operation. Events allow for a high degree of flexibility, so you can adapt to the specifications of the production line.

Event (Trigger conditions)		
Bit ON/OFF	Value comparison	Time setting

Action (Operations)		
Start/Stop of logging	Recipe read/write	Sampling readout
Application start-up	Stored data read/write	



# Remote monitoring and control TELLUS-Remote

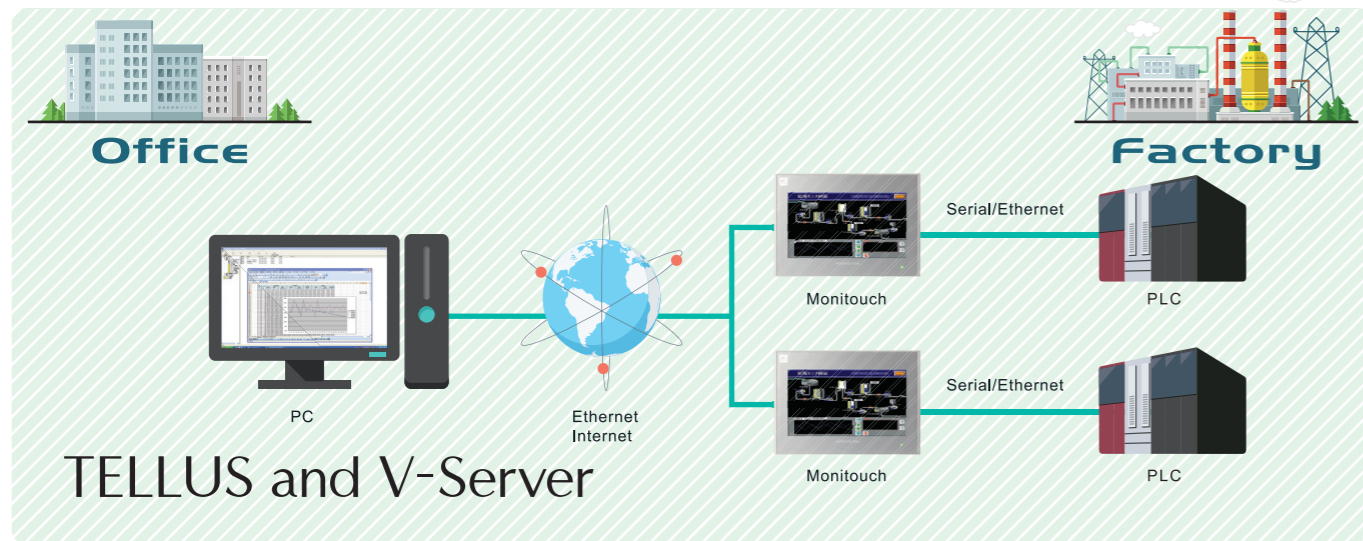

# Integration of PC and Monitouch improves performance beyond Monitouch's capacity. TELLUS-HMI

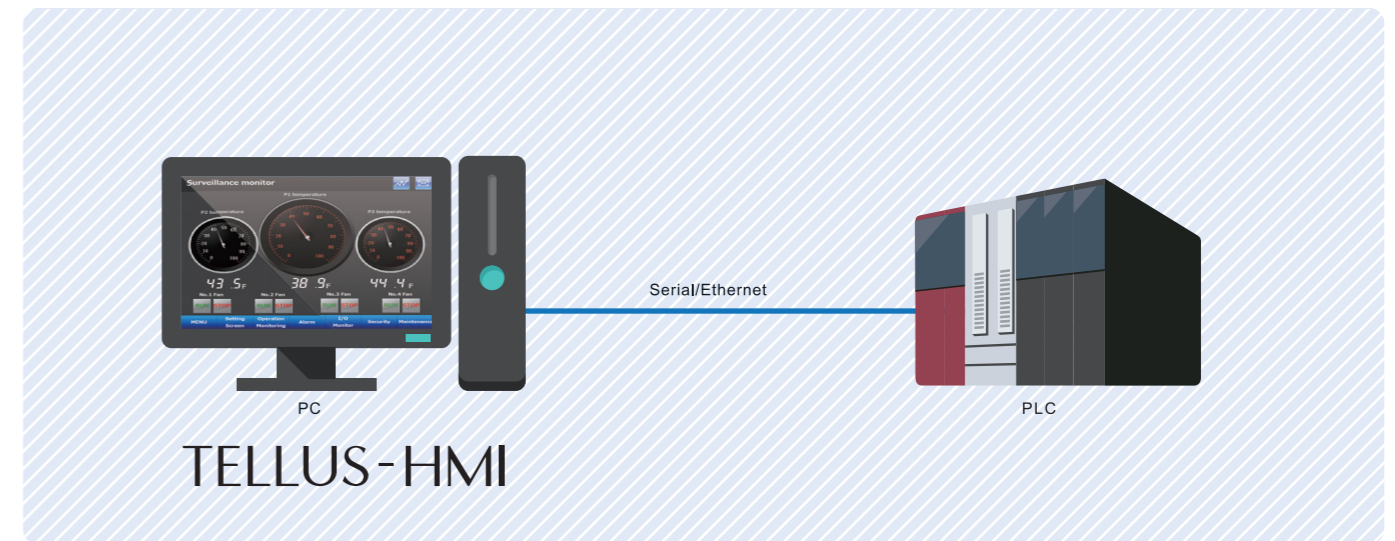

## Remote control with excellent cost performance

Conventional system			TELLUS and V-Server	
SCADA (Software)	Screen configuration and customization	Communication unit (PLC, etc.)	TELLUS and V-Server	Monitouch
Conventional remote control systems require an enormous amount of time and money; expensive equipment and software, exclusive programming by VB/ VC, etc. are needed.			Only installation of low-cost application software is needed. The same screen program as for Monitouch in production site can be used without making any additional screen program for remote monitoring.	
<b>High cost!</b>			<b>Low cost!</b>	

## Monitoring and control of multiple units by one PC

TELLUS allows you to control and monitor multiple Monitouch panels with a single PC, which helps improve the operating efficiency and the cost-effectiveness.

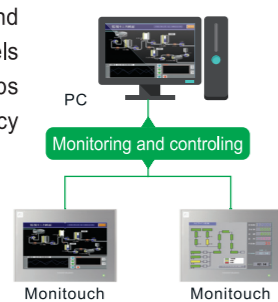

## Security functions against operation errors

Security functions such as write-protect are provided to ensure safe and secure system operation.

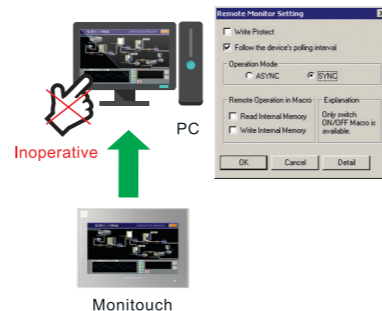

## Remote control by means of a simple system

The system is compatible with various systems such as in-house LAN, Internet, WAN, etc.

**You can access the on-site screen via the Internet from a remote location.**

**You can monitor overseas plants via WAN.**

\*It is necessary to modify the setting of firewall and routing for Internet access.

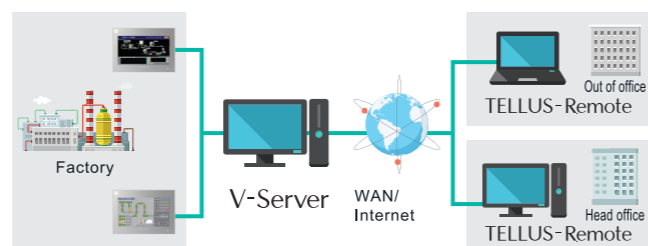

## Centralized monitoring of the entire factory with a large screen display

TELLUS HMI supports full HD resolution. The entire image, which cannot be displayed on one Monitouch display, can be displayed on a large screen display.

The diagram compares the resolution of a Monitouch V9150iX (1,024x768 pixels) with the TELLUS HMI display (1,920x1,080 pixels). The HMI display area is highlighted as 'Full HD display' and 'Screen Configuration'.

**Monitouch display area**  
1,024x768 pixels

**HMI mode display area**  
1,920x1,080 pixels

**Full HD display** Full HD 1080

**Screen Configuration**  
The screen is designed by means of the exclusive configuration software, V-SFT-6. TELLUS ver.4 allows you to edit in high resolution.

## Easy selection of peripheral equipment

It is possible to connect peripheral equipment such as printers and mass storage media that have Windows drivers so that the data can be easily output or saved.

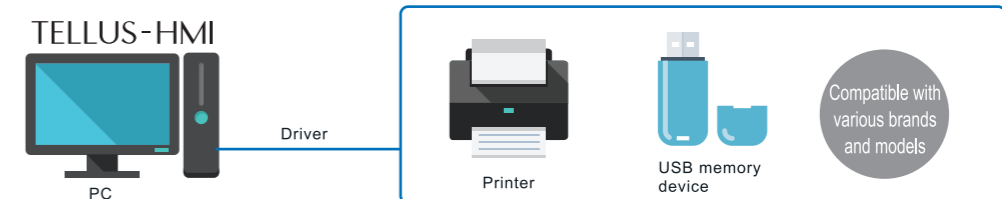

## Large expandability combined with various applications

Processing of production data such as summary and analysis can be easily conducted using external software.

The diagram shows 'TELLUS-HMI' connected to a 'PC'. Three icons represent different capabilities: 'Shutdown of OS', 'Start-up of application', and 'Loading and execution of DLL functions'.

**Shutdown of OS**  
OS can be shut down on TELLUS without displaying the shutdown menu.

**Start-up of application**  
Various applications can be run, including that for viewing a PDF of the troubleshooting manual.

**Loading and execution of DLL functions**  
DLL functions that were made individually can be loaded and executed on TELLUS.



## Advantages of using V-Server

**“I don't have to bother collecting data any more.”**



### Real-time collection of on-site production data

Production data can be collected in real time without burdening workers. Collected data can be used for reviewing production plans and improving production facilities.

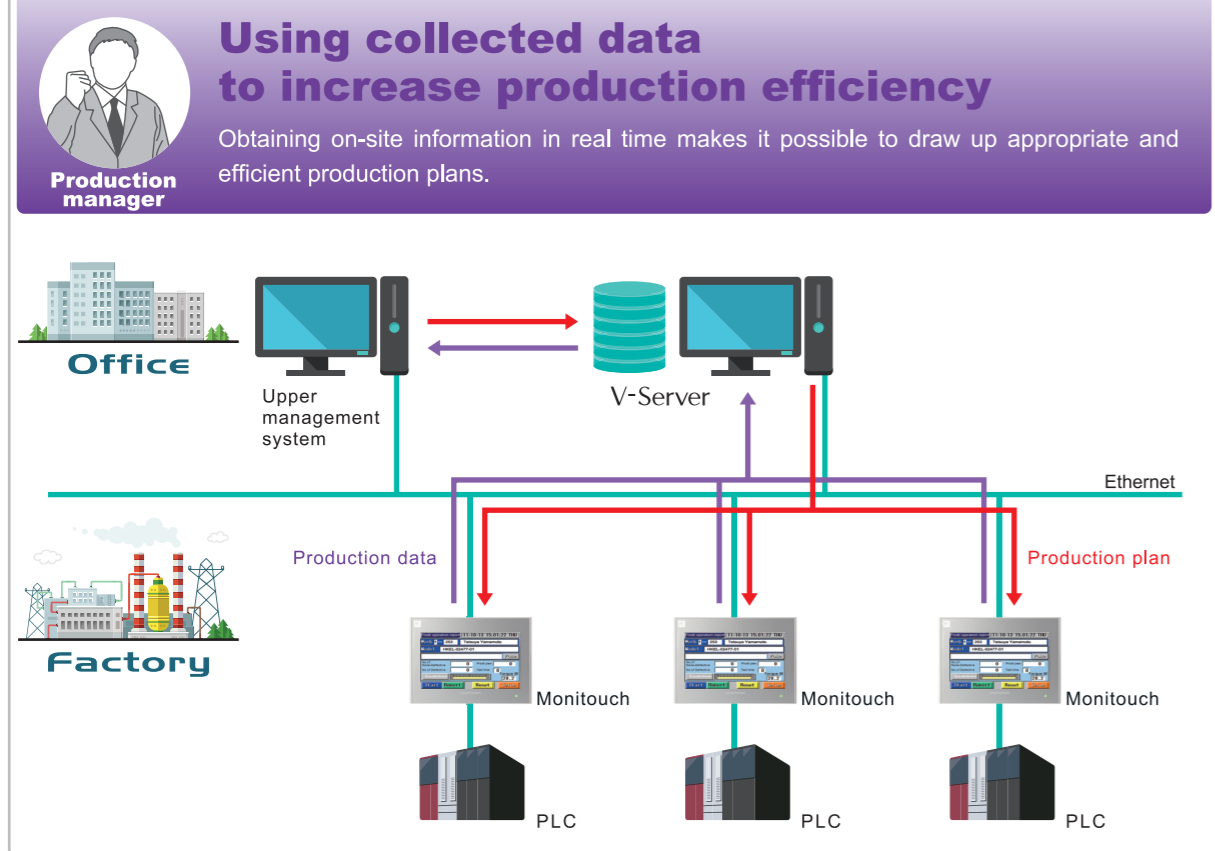

### Using collected data to increase production efficiency

Obtaining on-site information in real time makes it possible to draw up appropriate and efficient production plans.

Production manager



Worker

### Sending reports upon completion of work

Daily reports are made automatically and accurately to reduce the burden on the production worker and errors.



Maintenance worker

### Producing a database of problems

Data on operation stops and errors are analyzed to improve production facilities.

## Advantages of using TELLUS-Remote

**“We can shorten the downtime.”**



### Troubleshooting in the office for quick recovery

Prompt response to problems is possible by controlling the production equipment remotely. Production efficiency is improved by shortening downtime, and there is no need to spend the time and money required to send a person to the production site.

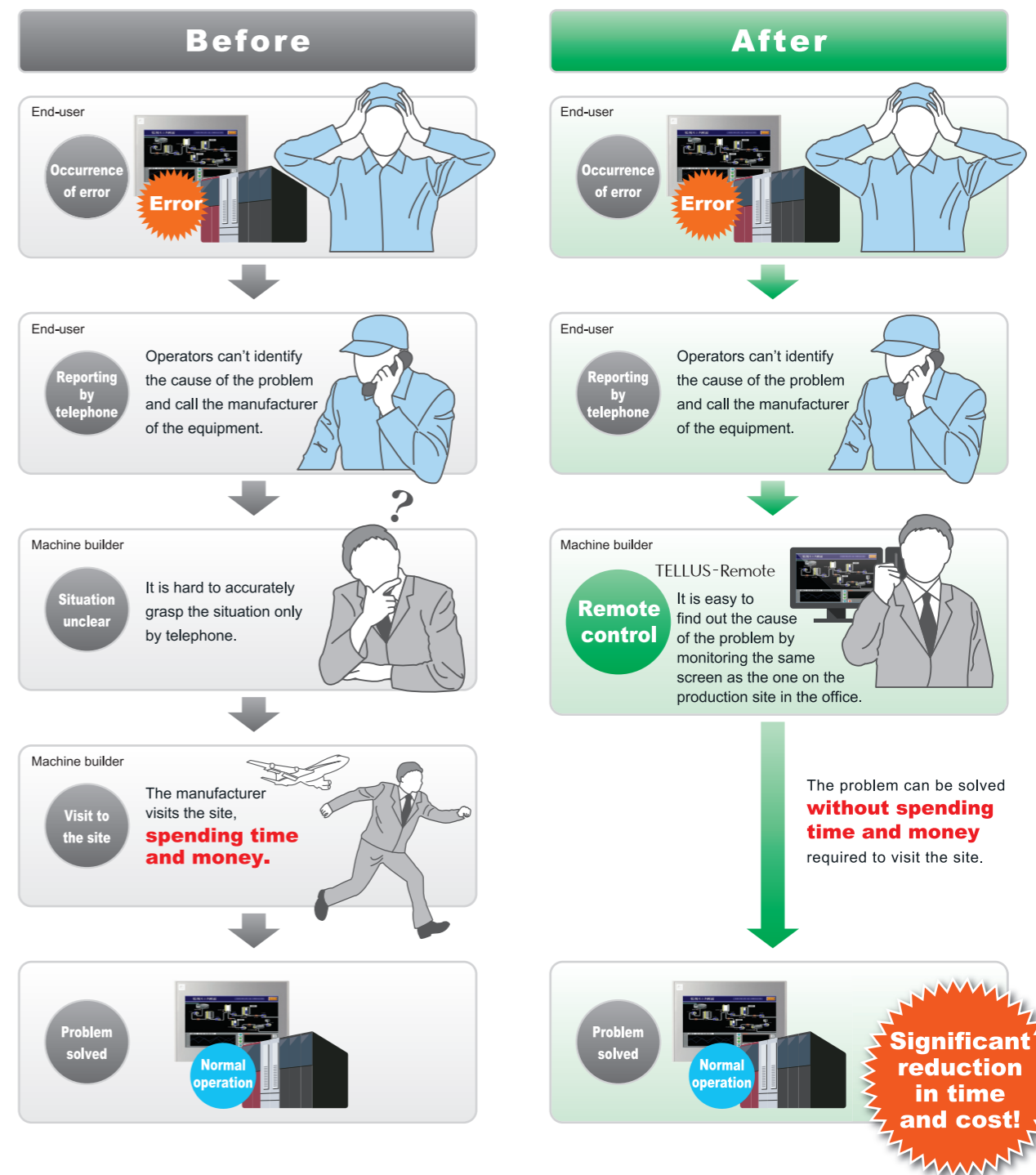

## Advantages of using TELLUS-HMI

**“I won't miss a problem in production.”**



**An image of the entire production line can be displayed on one large screen.**

Equipping a PC with Monitouch functions makes it possible to have a large, full HD display. All operation processes can be displayed on one large screen.

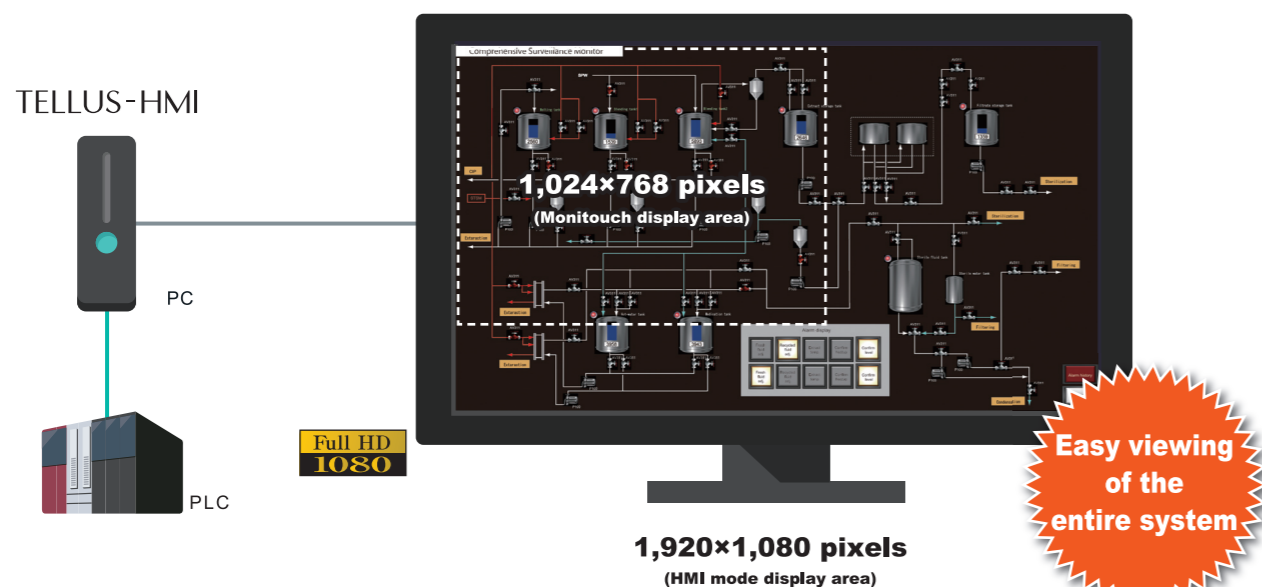

**Additional displays only for monitoring is available.**

Connection of a large display enables easy viewing of the image data.

**Run two TELLUS-HMIs and indicate the data on separate displays.**

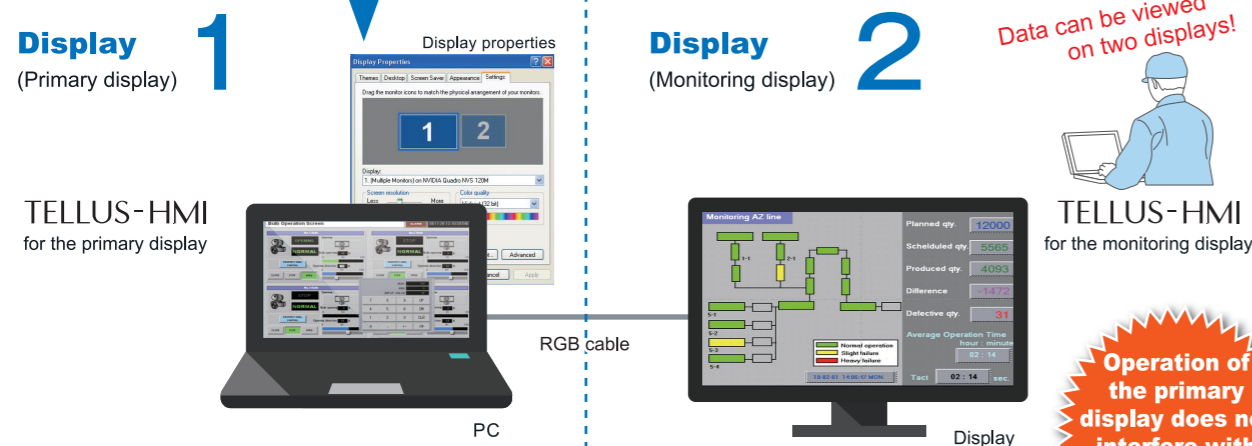

## Compatible Models & Operation Requirements

### Compatible Models

- V9 series
- V8iN/ TS2000i series
- V8N series + CUN-03-3 (Ethernet unit)

### Configuration Software

- V-SFT-6** Configuration software for Monitouch V9/ V8/ TS2000/ TS1000 series and TELLUS. You can easily create your own screen program as desired.

### Recommended Operating Environment

Please ensure the following conditions are in place for the operation of TELLUS and V-Server.

PC	IBM PC/ AT compatible with Windows
OS	Windows XP 32bit, 64bit/ Vista 32bit, 64bit/ Win7 32bit, 64bit/ Win8 32bit, 64bit/ Win8.1 32bit, 64bit/ Win10 32bit, 64bit/ Server 2008 R2/ Server 2012
CPU	Pentium IV 1GHz or more
Memory	256MB or more
Hard disk	1GB or more

## License Types

One license is required for each computer. There are four types of licenses depending on the function. (Licenses are framed in red as below.)

### 1 V-Server

The functions of V-Server are carried out by the server PC.

- Readout/ Writing of the recipe data for Monitouch (or TELLUS HMI)
- Alarm monitoring
- Event action
- Screen data transfer (excluding TELLUS-HMI)

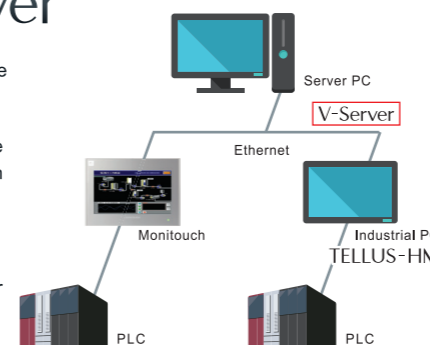

### 2 TELLUS-Remote

- A client PC equipped with TELLUS accesses V-Server on a server PC via Ethernet and operates the panels of Monitouch (or TELLUS HMI) remotely.
- HMI communication is also possible.

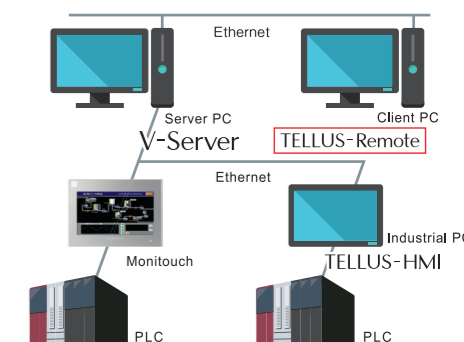

### 3 TELLUS and V-Server

- A server PC equipped with TELLUS and V-Server can remotely control the panels of Monitouch (or TELLUS HMI) while conducting V-Server functions.
- HMI communication is also possible.

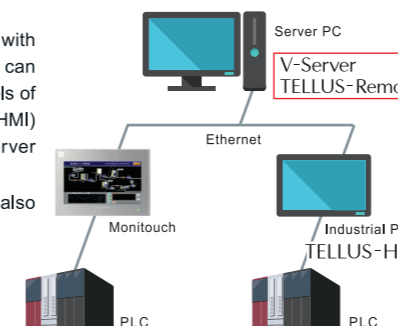

### 4 TELLUS-HMI

- A PC (or Industrial PC) equipped with TELLUS-HMI and connected with a PLC functions as a Monitouch panel.

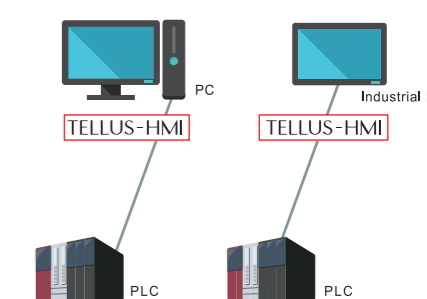

## License Validation

There are two types of licenses: Password type and USB license type.

### USB license key

- TELLUS-HMI USB Key
- TELLUS-Remote USB Key
- TELLUS and V-Server USB Key

### Password validation

- TELLUS-HMI
- TELLUS-Remote
- TELLUS and V-Server
- V-Server

### License Validation

License validation is restricted to one license per computer. There are four types of licenses, one for each function (See above). Check the type of license for the function(s) you wish to use it for.

Notes\*: When reinstalling the application software on the same computer, the same password is valid. However, if you initialize the OS or change the computer on which the application software is installed, the password becomes invalid. In this case, you must go through the license validation procedure again to get a new password.\* : Excluding the cases of using a USB license key



PLC models compatible with TELLUS

Manufacturer	Models	V9 series V8 series TS2060I	TS2060	TELLUS Ver.4			TELLUS Ver.3		
				TELLUS HMI		TELLUS Remote & V-Server	TELLUS HMI		TELLUS Remote & V-Server
				1:1	1:n		1:1	1:n	
Adept	AAC Protocol	✓	✓	✓	✓	✓	✓	✓	
Allen-Bradley	PLC-5	✓	✓	✓	✓	✓	✓	✓	
	PLC-5(Ethernet)	✓	✓	✓	✓	✓	✓	✓	
	SLC500	✓	✓	✓	✓	✓	✓	✓	
	SLC500(Ethernet TCP/IP)	✓	✓	✓	✓	✓	✓	✓	
	NET-ENI(SLC500 Ethernet TCP/IP)	✓	✓	✓	✓	✓	✓	✓	
	NET-ENI(MicroLogix Ethernet TCP/IP)	✓	✓	✓	✓	✓	✓	✓	
	Micro Logix	✓	✓	✓	✓	✓	✓	✓	
	Micro Logix(Ethernet TCP/IP)	✓	✓	✓	✓	✓	✓	✓	
	Control Logix/Compact Logix	✓	✓	✓	✓	✓	✓	✓	
	Control Logix(Ethernet)	✓	✓	✓	✓	✓	✓	✓	
Automationdirect	Micro800 Controllers	✓	✓	✓	✓	✓	✓	✓	
	Micro800 Controllers(Ethernet TCP/IP)	✓	✓	✓	✓	✓	✓	✓	
	Direct LOGIC	✓	✓	✓	✓	✓	✓	✓	
	Direct LOGIC(K-Sequence)	✓	✓	✓	✓	✓	✓	✓	
Azbil	Direct LOGIC(Ethernet UDP/IP)	✓	✓	✓	✓	✓	✓	✓	
	Direct LOGIC(Modbus RTU)	✓	✓	✓	✓	✓	✓	✓	
	IMX series	✓	✓	✓	✓	✓	✓	✓	
Baldor	DMC50(CTRL)	*8	*8	✓	✓	✓	✓		
Baumüller	Mint	✓	✓	✓	✓	✓	✓		
BECKHOFF	BMx-x-PLC	✓	✓	✓	✓	✓	✓		
CIMON	ADS Protocol(Ethernet)	✓	✓	✓	✓	✓	✓	✓	
	BP Series	✓	✓	✓	✓	✓	✓	✓	
	CP Series	✓	✓	✓	✓	✓	✓	✓	
	S Series	✓	✓	✓	✓	✓	✓	✓	
DELTA	S Series(Ethernet)	✓	✓	✓	✓	✓	✓	✓	
	DVP series	✓	✓	✓	✓	✓	✓	✓	
	DVP-SE(MODBUS ASCII)	✓	✓	✓	✓	✓	✓	✓	
EATON Cutler-Hammer	DVP-SE(MODBUS TCP/IP)	✓	✓	✓	✓	✓	✓	✓	
	ELC	✓	✓	✓	✓	✓	✓	✓	
EMERSON	EC10/EC20/EC20H (MODBUS RTU)	✓	✓	✓	✓	✓	✓		
FANUC	Power Mate	✓	✓	✓	✓	✓	✓		
Fatek Automation	FACON FB series	✓	✓	✓	✓	✓	✓		
FESTO	FEC	✓	✓	✓	✓	✓	✓		
FUFENG	APC Series Controller	✓	✓	✓	✓	✓	✓		
Fuji Electric	MICREX-F series	✓	✓	✓	✓	✓	✓	✓	
	MICREX-F series V4 Compatible	✓	✓	✓	✓	✓	✓	✓	
	MICREX-F Tlink	✓	✓	✓	✓	✓	✓	✓	
	MICREX-F Tlink V4 Compatible	✓	✓	✓	✓	✓	✓	✓	
	SPB(N mode)&FLEX-PC series	✓	✓	✓	✓	✓	✓	✓	
	SPB(N mode)&FLEX-PC CPU	✓	✓	✓	✓	✓	✓	✓	
	FLEX-PC COM(T)	✓	✓	✓	✓	✓	✓	✓	
	FLEX-PC(T)	✓	✓	✓	✓	✓	✓	✓	
	FLEX-PC CPU(T)	✓	✓	✓	✓	✓	✓	✓	
	FLEX-PC(OPCN-1)	✓	✓	✓	✓	✓	✓	✓	
	MICREX-SX(Tlink)	✓	✓	✓	✓	✓	✓	✓	
	MICREX-SX(OPCN-1)	✓	✓	✓	✓	✓	✓	✓	
	MICREX-SX(SX bus)	✓	✓	✓	✓	✓	✓	✓	
	MICREX-SX SPH/SPB/SPM/SPE series	✓	✓	✓	✓	✓	✓	✓	
	MICREX-SX SPH/SPB/SPM/SPE CPU	✓	✓	✓	✓	✓	✓	✓	
MICREX-SX(Ethernet)	✓	✓	✓	✓	✓	✓	✓		
GE Fanuc	90 series	✓	✓	✓	✓	✓	✓	✓	
	90 series(SNP-X)	✓	✓	✓	✓	✓	✓	✓	
	90 series(SNP)	✓	✓	✓	✓	✓	✓	✓	
	90 series(Ethernet TCP/IP)	✓	✓	✓	✓	✓	✓	✓	
Hitachi	FX3i(Ethernet TCP/IP)	✓	✓	✓	✓	✓	✓	✓	
	HIDIC-S10/2alpha.S10mini	✓	✓	✓	✓	✓	✓	✓	
	HIDIC-S10/2alpha.S10mini(Ethernet)	✓	✓	✓	✓	✓	✓	✓	
	HIDIC-S10/4alpha	✓	✓	✓	✓	✓	✓	✓	
	HIDIC-S10/ABS	✓	✓	✓	✓	✓	✓	✓	
Hitachi Industrial Equipment Systems	HIDIC-S10(OPCN-1)	✓	✓	✓	✓	✓	✓	✓	
	HIDIC-S10V	✓	✓	✓	✓	✓	✓	✓	
	HIDIC-S10V(Ethernet)	✓	✓	✓	✓	✓	✓	✓	
	HIDIC-H	✓	✓	✓	✓	✓	✓	✓	
	HIDIC-H (Ethernet)	✓	✓	✓	✓	✓	✓	✓	
	HIDIC-EHV	✓	✓	✓	✓	✓	✓	✓	
	HIDIC-EHV(Ethernet)	✓	✓	✓	✓	✓	✓	✓	
	Universal Modbus RTU	✓	✓	✓	✓	✓	✓	✓	
	Universal Modbus TCP/IP(Ethernet)	✓	✓	✓	✓	✓	✓	✓	
	H4 Robot(MODBUS RTU)	✓	✓	✓	✓	✓	✓	✓	
HYUNDAI	H4 Robot(MODBUS RTU)	✓	✓	✓	✓	✓	✓	✓	
	H4 Robot(MODBUS RTU)	✓	✓	✓	✓	✓	✓	✓	
IDEC	MICRO3	✓	✓	✓	✓	✓	✓	✓	
	MICRO Smart	✓	✓	✓	✓	✓	✓	✓	
Jetter	MICRO Smart Pentra	✓	✓	✓	✓	✓	✓	✓	
	JetControl Series2/3(Ethernet UDP/IP)	✓	✓	✓	✓	✓	✓	✓	
JTEKT	TOYOPUC	✓	✓	✓	✓	✓	✓	✓	
	TOYOPUC(Ethernet)	✓	✓	✓	✓	✓	✓	✓	
	TOYOPUC(Ethernet PC10Mode)	✓	✓	✓	✓	✓	✓	✓	
	TOYOPUC-Plus	✓	✓	✓	✓	✓	✓	✓	
	TOYOPUC-Plus(Ethernet)	✓	✓	✓	✓	✓	✓	✓	
KEYENCE	KZ series link	✓	✓	✓	✓	✓	✓	✓	
	KZ-A500 CPU	✓	✓	✓	✓	✓	✓	✓	
	KZKV series CPU	✓	✓	✓	✓	✓	✓	✓	
	KZ24/300 CPU	✓	✓	✓	✓	✓	✓	✓	
	KV10/24 CPU	✓	✓	✓	✓	✓	✓	✓	
	KV-700	✓	✓	✓	✓	✓	✓	✓	
	KV-700(Ethernet UDP/IP)	✓	✓	✓	✓	✓	✓	✓	
	KV-700(Ethernet TCP/IP)	✓	✓	✓	✓	✓	✓	✓	
	KV-1000	✓	✓	✓	✓	✓	✓	✓	
	KV-1000(Ethernet TCP/IP)	✓	✓	✓	✓	✓	✓	✓	
KOYO ELECTRONICS	KV-3000/5000	✓	✓	✓	✓	✓	✓	✓	
	KV-3000/5000(Ethernet TCP/IP)	✓	✓	✓	✓	✓	✓	✓	
	KV-7000(Ethernet TCP/IP)	✓	✓	✓	✓	✓	✓	✓	
	SUSG	✓	✓	✓	✓	✓	✓	✓	
	SR-T	✓	✓	✓	✓	✓	✓	✓	
	SR-T(K prt)	✓	✓	✓	✓	✓	✓	✓	
	SU/SG(K-Sequence)	✓	✓	✓	✓	✓	✓	✓	
	SU/SG(Modbus RTU)	✓	✓	✓	✓	✓	✓	✓	
	MASTER-K1060/200	✓	✓	✓	✓	✓	✓	✓	
	MASTER-K500/1000	✓	✓	✓	✓	✓	✓	✓	
LS	MASTER-KxxxS	✓	✓	✓	✓	✓	✓	✓	
	MASTER-KxxxS CNET	✓	✓	✓	✓	✓	✓	✓	
	MASTER-K series(Ethernet)	✓	✓	✓	✓	✓	✓	✓	
	GLOFA CNET	✓	✓	✓	✓	✓	✓	✓	
	GLOFA GM7 CNET	✓	✓	✓	✓	✓	✓	✓	
	GLOFA GM series CPU	✓	✓	✓	✓	✓	✓	✓	
	GLOFA GM series(Ethernet UDP/IP)	✓	✓	✓	✓	✓	✓	✓	
	GLOFA GMR series(Ethernet)	✓	✓	✓	✓	✓	✓	✓	
	XGT/XGK series CNET	✓	✓	✓	✓	✓	✓	✓	
	XGT/XGK series CPU	✓	✓	✓	✓	✓	✓	✓	
	XGT/XGK series(Ethernet)	✓	✓	✓	✓	✓	✓	✓	
	XGT/XGI series CNET	✓	✓	✓	✓	✓	✓	✓	
	XGT/XGI series CPU	✓	✓	✓	✓	✓	✓	✓	
	XGT/XGI series(Ethernet)	✓	✓	✓	✓	✓	✓	✓	
	MITSUBISHI ELECTRIC	A series link	✓	✓	✓	✓	✓	✓	✓
A series CPU		✓	✓	✓	✓	✓	✓	✓	
A series(OPCN-1)		✓	✓	✓	✓	✓	✓	✓	
QnA series link		✓	✓	✓	✓	✓	✓	✓	
QnA series CPU		✓	✓	✓	✓	✓	✓	✓	
QnA series(Ethernet)		✓	✓	✓	✓	✓	✓	✓	
QnH(Q) series link		✓	✓	✓	✓	✓	✓	✓	
QnH(A) series CPU		✓	✓	✓	✓	✓	✓	✓	
QnH(Q) series CPU		✓	✓	✓	✓	✓	✓	✓	
QnU series CPU		✓	✓	✓	✓	✓	✓	✓	
Q00J/Q00I CPU		✓	✓	✓	✓	✓	✓	✓	
QnH(Q) series(Ethernet)		✓	✓	✓	✓	✓	✓	✓	
QnH(Q) series link (Multi CPU)		✓	✓	✓	✓	✓	✓	✓	
QnH(Q) series (Multi CPU) (Ethernet)		✓	✓	✓	✓	✓	✓	✓	
QnH(Q) series CPU (Multi CPU)		✓	✓	✓	✓	✓	✓	✓	
QnH(Q) series(Ethernet ASCII)	✓	✓	✓	✓	✓	✓	✓		
QnH(Q) series (Multi CPU) (Ethernet ASCII)	✓	✓	✓	✓	✓	✓	✓		
QnU series(Built-in Ethernet)	✓	✓	✓	✓	✓	✓	✓		
L series link	✓	✓	✓	✓	✓	✓	✓		
L series(Built-in Ethernet)	✓	✓	✓	✓	✓	✓	✓		

✓: Supported -: Not supported Note1: TELLUS HMI is not compatible with Multi-link and Multi-link2. Note2: Macro PLC\_CTL by remote control is not compatible. \*1: Even though (compatible) is shown, when TELLUS(HMI) serial connection is not available, the message "Remote is not compatible" is shown. Execute regardless of the message. \*2: When "Memory check" and "bit" are selected in the event setting of V-Server, upper bits(16~31 bits) in double-word devices cannot be used.

Manufacturer	Models	V9 series V8 series TS2060I	TS2060	TELLUS Ver.4			TELLUS Ver.3		
				TELLUS HMI		TELLUS Remote & V-Server	TELLUS HMI		TELLUS Remote & V-Server
				1:1	1:n		1:1	1:n	
MITSUBISHI ELECTRIC	L series CPU	✓	✓	✓	✓	✓	✓	✓	
	A series(CC-LINK)	✓	✓	✓	✓	✓	✓	✓	
	QnA series(CC-LINK)	✓	✓	✓	✓	✓	✓	✓	
	QnH(Q) series(CC-LINK)	✓	✓	✓	✓	✓	✓	✓	
	FX series CPU	✓	✓	✓	✓	✓	✓	✓	
	FX2N/1N series CPU	✓	✓	✓	✓	✓	✓	✓	
	FX1S series CPU	✓	✓	✓	✓	✓	✓	✓	
	FX series link(A-prt)	✓	✓	✓	✓	✓	✓	✓	
	FX3U/3UC/3G series CPU	✓	✓	✓	✓	✓	✓	✓	
	FX3U/3GE series (Ethernet)	✓	✓	✓	✓	✓	✓	✓	
	FX3U/3UC/3G series link (A-prt)	✓	✓	✓	✓	✓	✓	✓	
	FX3U/3UC series	✓	✓	✓	✓	✓	✓	✓	
	FX3U/3UC series (Ethernet)	✓	✓	✓	✓	✓	✓	✓	
	Net10	✓	✓	✓	✓	✓	✓	✓	
	Alink+Net10	✓	✓	✓	✓	✓	✓	✓	
	Q170MCPUI(Multi CPU)	✓	✓	✓	✓	✓	✓	✓	
	Q170 series(Multi CPU)(Ethernet)	✓	✓	✓	✓	✓	✓	✓	
	IQ-R series (Built-in Ethernet)	✓	✓	✓	✓	✓	✓	✓	
	IQ-R series link	✓	✓	✓	✓	✓	✓	✓	
	IQ-R series(Ethernet)	✓	✓	✓	✓	✓	✓	✓	
	MODICON	Modbus RTU	✓	✓	✓	✓	✓	✓	
	MOELLER	PS4	✓	✓	✓	✓	✓	✓	
	OMRON	SYSMAC C	✓	✓	✓	✓	✓	✓	
		SYSMAC C(OPCN-1)	✓	✓	✓	✓	✓	✓	
		SYSMAC CV	✓	✓	✓	✓	✓	✓	
SYSMAC CS1/CJ1		✓	✓	✓	✓	✓	✓		
SYSMAC CS1/CJ1 DNA		✓	✓	✓	✓	✓	✓		
SYSMAC CS1/CJ1(Ethernet)		✓	✓	✓	✓	✓	✓		
SYSMAC CS1/CJ1(Ethernet Auto)		✓	✓	✓	✓	✓	✓		
SYSMAC CS1/CJ1 DNA(Ethernet)		✓	✓	✓	✓	✓	✓		
NJ Series(EtherNet/IP)		✓	✓	✓	✓				

Temperature controllers, Servo units and inverters compatible with TELLUS

Manufacturer	Models	V9 series V8 series TS20601	TS2060	TELLUS Ver.4		TELLUS Ver.3	
				TELLUS HMI	TELLUS Remote & V-Server	TELLUS HMI	TELLUS Remote & V-Server
A&D	AD442(MODBUS RTU)	✓	✓	✓	✓	-	-
	AD444(MODBUS RTU)	✓	✓	✓	✓	-	-
Agilent	4263 Series	✓	✓	✓	✓	-	-
Azbil	SDC10	✓	✓	✓	✓	-	-
	SDC15	✓	✓	✓	✓	-	-
	SDC20	✓	✓	✓	✓	-	-
	SDC21	✓	✓	✓	✓	-	-
	SDC25/26	✓	✓	✓	✓	-	-
	SDC30/31	✓	✓	✓	✓	-	-
	SDC35/36	✓	✓	✓	✓	-	-
	SDC45/46	✓	✓	✓	✓	-	-
	SDC40A	✓	✓	✓	✓	-	-
	SDC40G	✓	✓	✓	✓	-	-
	DMC10	✓	✓	✓	✓	-	-
	DMC50(CTRL)	*1	*1	*1	*1	-	-
	DMC50(COM)	✓	✓	✓	✓	-	-
	AHC2001	✓	✓	✓	✓	-	-
	AHC2001+DCP31/32	✓	✓	✓	✓	-	-
	DCP31/32	✓	✓	✓	✓	-	-
	NX(CPL)	✓	✓	✓	✓	-	-
	NX(Modbus RTU)	✓	✓	✓	✓	-	-
	NX(Modbus TCP/IP)	✓	✓	✓	✓	-	-
Banner	PresencePLUS(Ethernet/IP(TCP/IP))	✓	✓	✓	✓	-	-
Bosch Rexroth	IndraDrive	✓	✓	✓	✓	-	-
CHINO	DZ1000(MODBUS RTU)	-	-	-	-	-	-
	DZ2000(MODBUS RTU)	-	-	-	-	-	-
	KP1000	-	-	-	-	-	-
	LT400 Series(MODBUS RTU)	✓	✓	✓	✓	-	-
	DP1000	✓	✓	✓	✓	-	-
	DB1000	✓	✓	✓	✓	-	-
	DB1000B(MODBUS RTU)	✓	✓	✓	✓	-	-
	KR2000(MODBUS RTU)	✓	✓	✓	✓	-	-
	LT230(MODBUS RTU)	✓	✓	✓	✓	-	-
	LT300(MODBUS RTU)	✓	✓	✓	✓	-	-
	LT830(MODBUS RTU)	✓	✓	✓	✓	-	-
Danfoss	VLT series	-	-	-	-	-	-
DELTA TAU DATA SYSTEMS	PMAC	✓	✓	✓	✓	-	-
	PMAC(Ethernet TCP/IP)	✓	✓	✓	✓	-	-
EUROTHERM	2400 series (MODBUS RTU)	✓	✓	✓	✓	-	-
Fuji Electric	PYX(MODBUS RTU)	-	-	-	-	-	-
	PYH	-	-	-	-	-	-
	PXR(MODBUS RTU)	✓	✓	✓	✓	-	-
	PXF(MODBUS RTU)	✓	✓	✓	✓	-	-
	PXG(MODBUS RTU)	✓	✓	✓	✓	-	-
	PXH(MODBUS RTU)	✓	✓	✓	✓	-	-
	PUM(MODBUS RTU)	✓	✓	✓	✓	-	-
	F-MPC04P(Loader)	✓	✓	✓	✓	-	-
	F-MPC Series /FePSU	✓	✓	✓	✓	-	-
	FVR-E11S	✓	✓	✓	✓	-	-
	FVR-E11S(MODBUS RTU)	✓	✓	✓	✓	-	-
	FVR-C11S	✓	✓	✓	✓	-	-
	FVR-C11S(MODBUS RTU)	✓	✓	✓	✓	-	-
	FRENIC500G11S/P11S	✓	✓	✓	✓	-	-
	FRENIC500G11S/P11S(MODBUS RTU)	✓	✓	✓	✓	-	-
	FRENIC500V7S	✓	✓	✓	✓	-	-
	FRENIC500V7S(MODBUS RTU)	✓	✓	✓	✓	-	-
	FRENIC-IVAC/AQUA(MODBUS RTU)	✓	✓	✓	✓	-	-
	FRENIC-Mini(MODBUS RTU)	✓	✓	✓	✓	-	-
	FRENIC-Ace(MODBUS RTU)	✓	✓	✓	✓	-	-
	FRENIC-Eco(MODBUS RTU)	✓	✓	✓	✓	-	-
	FRENIC-Multi(MODBUS RTU)	✓	✓	✓	✓	-	-
	FRENIC MEGA(MODBUS RTU)	✓	✓	✓	✓	-	-
	FRENIC MEGA SERVO(MODBUS RTU)	✓	✓	✓	✓	-	-
	FRENIC-VG1(MODBUS RTU)	✓	✓	✓	✓	-	-
	FRENIC Series (Loader)	✓	✓	✓	✓	-	-
	HFR-C9K	✓	✓	✓	✓	-	-
	HFR-C11K	✓	✓	✓	✓	-	-
	HFR-K1K	✓	✓	✓	✓	-	-
	PPMC(MODBUS RTU)	✓	✓	✓	✓	-	-
	FALDIC-alpha series	✓	✓	✓	✓	-	-
	FALDIC-W series	✓	✓	✓	✓	-	-
	PH series	✓	✓	✓	✓	-	-
	PHR(MODBUS RTU)	✓	✓	✓	✓	-	-
	WA5000	✓	✓	✓	✓	-	-
	APR-N(MODBUS RTU)	✓	✓	✓	✓	-	-
	ALPHAS (MODBUS RTU)	✓	✓	✓	✓	-	-
	ALPHAS Smart (MODBUS RTU)	✓	✓	✓	✓	-	-
	WE1MA(Ver.A)(MODBUS RTU)	✓	✓	✓	✓	-	-
	WE1MA(Ver.B)(MODBUS RTU)	✓	✓	✓	✓	-	-
	WSZ series	✓	✓	✓	✓	-	-
	WSZ series(Ethernet)	✓	✓	✓	✓	-	-
Gammaflux	TTC2100	✓	✓	✓	✓	-	-
HBM	FIT/5 JAD103	-	-	-	-	-	-
High-Pressure Gas Industry	R-BLT	✓	✓	✓	✓	-	-
Hitachi Industrial Equipment Systems	SJ300 series	✓	✓	✓	✓	-	-
	SJ700 series	✓	✓	✓	✓	-	-
	L300P series	✓	✓	✓	✓	-	-
Honeywell	Universal Modbus RTU	-	-	-	-	-	-
	DC1000	-	-	-	-	-	-
IAI	Super SEL Controller	-	-	-	-	-	-
	X-SEL Controller	-	-	-	-	-	-
	ROBO CYLINDER(RCP2/ERC)	✓	✓	✓	✓	-	-
	ROBO CYLINDER(RCS)	✓	✓	✓	✓	-	-
	ROBO CYLINDER(RCS/E-CON)	✓	✓	✓	✓	-	-
	TX-C1	-	-	-	-	-	-
	PCON/ACON/SCON(MODBUS RTU)	✓	✓	✓	✓	-	-
Koganei	IBFL-TC	✓	✓	✓	✓	-	-
	ABSRCD/ABSRXC	-	-	-	-	-	-
	ABPRC	-	-	-	-	-	-
Lenze	Servo Drive 9400(Ethernet TCP/IP)	✓	✓	✓	✓	-	-
LS	iS5	✓	✓	✓	✓	-	-
	iG5	✓	✓	✓	✓	-	-
	LGRF-H Reader	-	-	-	-	-	-
MITSUBISHI ELECTRIC	FR-E700	✓	✓	✓	✓	-	-
	FR-V500	✓	✓	✓	✓	-	-
	MR-J2S-A	✓	✓	✓	✓	-	-
	MR-J2S-CL	-	-	-	-	-	-
	MR-J2S-CP	-	-	-	-	-	-
	MR-J3-A	✓	✓	✓	✓	-	-
	MR-J3-T	✓	✓	✓	✓	-	-
	FR-700(MODBUS RTU)	✓	✓	✓	✓	-	-
	FR-E700	✓	✓	✓	✓	-	-
MOOG	J124-04x series	✓	✓	✓	✓	-	-
M-SYSTEM	R1M series (MODBUS RTU)	✓	✓	✓	✓	-	-
	R5 series (MODBUS RTU)	✓	✓	✓	✓	-	-
NIKKI DENSO	SQB-6432B	-	-	-	-	-	-
OHKURA	EC500S	-	-	-	-	-	-

✓: Supported -/: Not supported  
 Note 1: TEMP\_CTL macro command is not available for Remote mode. \*1: Integrated to DMC50(COM).

Manufacturer	Models	V9 series V8 series TS20601	TS2060	TELLUS Ver.4		TELLUS Ver.3	
				TELLUS HMI	TELLUS Remote & V-Server	TELLUS HMI	TELLUS Remote & V-Server
OHKURA	EC500	-	-	-	-	-	-
	EC560S	-	-	-	-	-	-
	EC5900A	-	-	-	-	-	-
OMRON	ESAK	✓	✓	✓	✓	-	-
	ESAK-T	✓	✓	✓	✓	-	-
	ESAN/ESEN/E5CN/E5GN	✓	✓	✓	✓	-	-
	ESAR/E5ER	✓	✓	✓	✓	-	-
	E5CK	✓	✓	✓	✓	-	-
	E5CK-T	✓	✓	✓	✓	-	-
	E5CN-HT	✓	✓	✓	✓	-	-
	E5EK	✓	✓	✓	✓	-	-
	E5EK-T	✓	✓	✓	✓	-	-
	E5ZD	✓	✓	✓	✓	-	-
	E5ZE	✓	✓	✓	✓	-	-
	E5ZN	✓	✓	✓	✓	-	-
	V600/620/680	✓	✓	✓	✓	-	-
	3G3MV(MODBUS RTU)	✓	✓	✓	✓	-	-
	KM20	✓	✓	✓	✓	-	-
	KM100	✓	✓	✓	✓	-	-
	V680S(Ethernet TCP/IP)	✓	✓	✓	✓	-	-
Orientalmotor	High-efficiency AR Series(MODBUS RTU)	✓	✓	✓	✓	-	-
	CRK Series(MODBUS RTU)	✓	✓	✓	✓	-	-
Panasonic	MINAS A4 Series	✓	✓	✓	✓	-	-
	LP-200/LP-F10	-	-	-	-	-	-
	LP-300	-	-	-	-	-	-
	LP-400	-	-	-	-	-	-
	LP-V10	-	-	-	-	-	-
	LP-W052	-	-	-	-	-	-
	KW Series	✓	✓	✓	✓	-	-
	LVDP	-	-	-	-	-	-
Parker	SR-Mini(MODBUS RTU)	✓	✓	✓	✓	-	-
RKC	CB100/CB400/CB500/CB700/CB900(MODBUS RTU)	✓	✓	✓	✓	-	-
	SR-Mini(Standard Protocol)	✓	✓	✓	✓	-	-
	REX-F400/F700/F900(Standard Protocol)	✓	✓	✓	✓	-	-
	REX-F900(Standard Protocol)	✓	✓	✓	✓	-	-
	SRV(MODBUS RTU)	✓	✓	✓	✓	-	-
	REX-B800(Standard Protocol)	-	-	-	-	-	-
	MA900/MA901(MODBUS RTU)	✓	✓	✓	✓	-	-
	SRZ(MODBUS RTU)	✓	✓	✓	✓	-	-
	FB100/FB400/FB900(MODBUS RTU)	✓	✓	✓	✓	-	-
RS Automation	CDS5(MODBUS RTU)	✓	✓	✓	✓	-	-
	Moscon-F50(MODBUS RTU)	✓	✓	✓	✓	-	-
SAMSUNG	MOSCON-E7	-	-	-	-	-	-
SANKEN ELECTRIC	SAMCO-e	-	-	-	-	-	-
	SAMCO-vm05	-	-	-	-	-	-
SANMEI	Cuty Axis	✓	✓	✓	✓	-	-
	Cuty Axis3	✓	✓	✓	✓	-	-
SanRex	DC-AUTO (HKD type)	✓	✓	✓	✓	-	-
SANYO	PB1 series	-	-	-	-	-	-
SHARP	DS-300	✓	✓	✓	✓	-	-
	DS-32D	✓	✓	✓	✓	-	-
SHIMADEN	Shimaden Standard Protocol	✓	✓	✓	✓	-	-
SHINKO TECHNOS	C Series	✓	✓	✓	✓	-	-
	FC Series	✓	✓	✓	✓	-	-
	GC Series	✓	✓	✓	✓	-	-
	DCL-33A	✓	✓	✓	✓	-	-
	JCX-300 Series	✓	✓	✓	✓	-	-
	PC-900	✓	✓	✓	✓	-	-
	PCD-33A	✓	✓	✓	✓	-	-
	ACS-13A	✓	✓	✓	✓	-	-
	ACD/ACR Series	✓	✓	✓	✓	-	-
	WCL-13A	✓	✓	✓	✓	-	-
SICK	DME3000	-	-	-	-	-	-
Siemens	S120(Ethernet ISOTCP)	✓	✓	✓	✓	-	-
	MicroMaster 400	-	-	-	-	-	-
	USS Protocol	✓	✓	✓	✓	-	-